

# INSTRUCTION MANUAL



optiview<sub>inc</sub>

PAL  NTSC



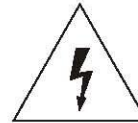

**CAUTION**  
RISK OF ELECTRIC  
SHOCK DO NOT OPEN



**CAUTION:** TO REDUCE THE RISK OF ELECTRICAL SHOCK, DO NOT OPEN COVERS.  
NO USER SERVICEABLE PARTS INSIDE.  
REFER SERVICING TO QUALIFIED SERVICE PERSONAL.



This lightning flash with arrowhead symbol is intended to alert the user to the presence of un-insulated "dangerous voltage" within the product's enclosure that may be of sufficient magnitude to constitute a risk of electric shock to persons.



This exclamation point symbol is intended to alert the user to the presence of important operating and maintenance (servicing) instructions in the literature accompanying the appliance.

**WARNING:** TO PREVENT THE RISK OF FIRE OR ELECTRIC SHOCK HAZARD DO NOT EXPOSE  
THIS CAMERATO RAIN OR MOISTURE.



### Important Safeguard

1. **Read Instructions**  
Read all of the safety and operating instructions before using the product.
2. **Retain Instructions**  
Save these instructions for future reference.
3. **Attachments/Accessories**  
Do not use attachments or accessories unless recommended by the appliance manufacturer as they may cause hazards, damage product and void warranty.
4. **Water and Moisture**  
Do not use this product near water or moisture.
5. **Installation**  
Do not place or mount this product in or on an unstable or improperly supported location. Improperly installed product may fall, causing serious injury to a child or adult, and damage to the product. Use only with a mounting device recommended by the manufacturer, or sold with the product. To insure proper mounting, follow the manufacturer's instructions and use only mounting accessories recommended by manufacturer.
6. **Power source**  
This product should be operated only from the type of power source indicated on the marking label.

### Precautions

- Operating**
  - Before using, make sure power supply and others are properly connected.
  - While operating, if any abnormal condition or malfunction is observed, stop using the camera immediately and then contact your local dealer.
- Handling**
  - Do not disassemble or tamper with parts inside the camera.
  - Do not drop or subject the camera to shock and vibration as this can damage camera.
  - Care must be taken when you clean the clear dome cover. Especially, scratch and dust will ruin your quality of camera.
- Installation and Storage**
  - Do not install the camera in areas of extreme temperature, which exceed the allowable range.
  - Avoid installing in humid or dusty places.
  - Avoid installing in places where radiation is present.
  - Avoid installing in places where there are strong magnetic fields and electric signals.
  - Avoid installing in places where the camera would be subject to strong vibrations.
  - Never expose the camera to rain and water.

# SPECIFICATIONS 5

# CONTENTS

## Dimension

D650

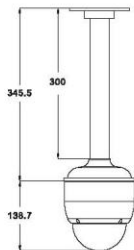
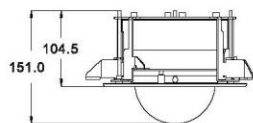
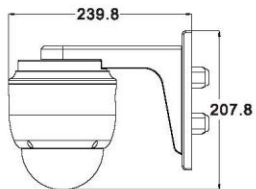

D661

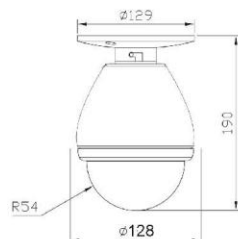
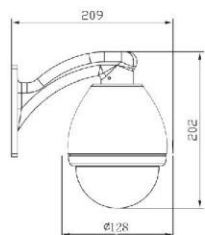

D662

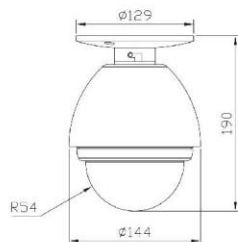
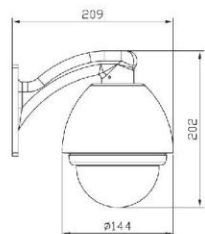

Unit(mm)

## ① Introduction

Features	4
Product & Accessories	6

## ② Installation

DIP Switch Setup	7
Cable connection	9

## ③ Operation

Checking Before Operation	11
Preset and Pattern Function Pre-Check	11
Start OSD Menu	12
Reserved Preset	12
Preset	13
Swing	13
Pattern	14
Group	15
Other Functions	16
OSD Display of Main Screen	17

## ④ How to use OSD Menu

General Rules of Menu Operation	18
Main Menu	18
Display Menu for Main Screen	19
Privacy Zone Mask Setup	20
Camera Module Setup	21
Motion Setup	23
Preset Setup	25
Swing Setup	27
Pattern Setup	28
Group Setup	29
System Initialize	31

## ⑤ Specifications

Dimension	33
-----------	----



**Features**

□ Camera Specifications

- CCD Sensor : 1/4" Interline Transfer CCD
- Zoom Magnification : ×10 Optical Zoom, ×10 Digital Zoom (Max ×100 Zoom)
- Day & Night Function
- Various Focus Mode : Auto-Focus / Manual Focus / Semi-Auto Focus.
- Independent & Simultaneous Camera Characteristic Setup in Preset operation

□ Powerful Pan/Tilt Functions

- Max. 360°/sec high speed Pan/Tilt Motion
- Using Vector Drive Technology, Pan/Tilt motions are accomplished in a shortest path. For Shanghai.com. As a result, time to target view is reduced dramatically and the video on the monitor is very natural to watch.
- For jog operation using a controller, since ultra slow speed 0.05°/sec can be reached, it is very easy to locate camera to desired target view. Additionally it is easy to move camera to a desired position with zoom-proportional pan/tilt movement.

□ Preset, Pattern, Swing, Group, Privacy Mask and More...

- MAX. 127 Presets are assignable and characteristics of each preset can be set up independently, such as White Balance, Auto Exposure, Label and so on.
- Max. 8 set of Swing action can be stored. This enables to move camera repetitively between two preset positions with designated speed.
- Max. 4 of Patterns can be recorded and played back. This enables to move camera to follow any trajectory operated by joystick as closely as possible.
- Max- 8 set of Group action can be stored. This enables to move camera repetitively with combination of Preset or Pattern or Swing. A Group is composed of max. 20 entities of Preset/Pattern/Swings.
- Privacy Masks are assignable, not to intrude on other's privacy. (4 Privacy Zones)

□ PTZ (Pan/Tilt/Zoom) Control

- With RS-485 communication, max. 255 of cameras can be controlled at the same time.
- Pelco-D or Pelco-P protocol can be selected as a control protocol in the current version of firmware.

**Dimension**

● Main Unit & Surface Mount Bracket

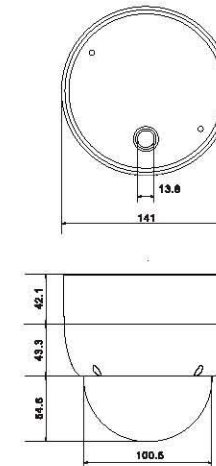

● Ceiling Mount Bracket

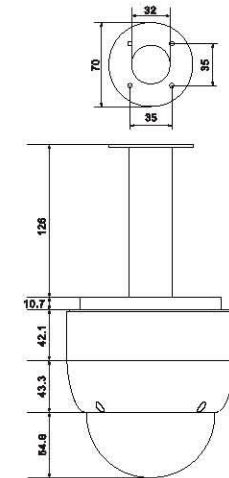

● Wall Mount Bracket

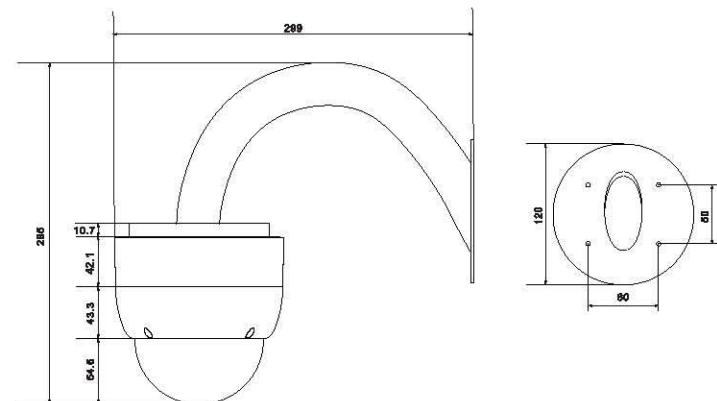

Unit(mm)

Video Signal System	NTSC	PAL		
CCD	1/4" Interline Transfer CCD			
Max. Pixels	811(H) × 508(V) 410K	795(H) × 596(V) 470K		
Effective Pixels	768(H) × 494(V) 380K	752(H) × 582(V) 440K		
Horizontal Res.	500 TV Line(Color), 570 TV Line(B/W)			
S/N Ratio	50 dB (AGC Off)			
Zoom	× 10 Optical zoom, × 10 Digital Zoom			
Focal length	F1.8, f=3.8~38mm			
Min. Illumination	0.7 Lux(Color) / 0.02 Lux (B/W), 50 IRE			
Day & Night	Auto / Day / Night(ICR)			
Focus	Auto / Manual / SemiAuto			
Iris	Auto / Manual			
Shutter Speed	X128 ~ 1/120000 sec			
AGC	Normal / High / Off			
White Balance	Auto / Manual(Red, Blue Gain Adjustable)			
BLC	Low / Middle / High / Off			
Flickerless	Selectable			
SSNR	Low / Middle / High / Off			
Pan/Tilt	Range	Pan : 360°(Infinite) Tilt : 180°(Auto-Flip), 95° (Normal)		
	Pan/Tilt Speed	Preset : 360°/sec Manual : 0.05~360°/sec(proportional to zoom) Swing : 1~180°/sec		
	Preset	127 Preset(Label, Camera Image Setting)		
	Pattern	4 Pattern, 1200 commands(about 5 minute)/pattern		
	Swing	8 Swing		
	Group	8 Group (20 action entities per Group)		
Other Functions	Auto flip, Auto Parallax, Power Up Action etc.			
General	Communication	RS-485		
	Protocol	Pelco-D, Pelco-P selectable		
	Privacy Zone	4 Zone		
	Alarm Input	4 Input		
	OSD	Menu / PTZ information etc		
	Rated Power	DC 12V / 0.8A		
	Dimension	Dome :	Φ100.5	
		Housing :	Φ141 × 140(H)mm	
Weight	about 1.2 Kg			
Operating Temp.	0°C ~ 40°C			

\* Specifications of this product can be subjected to change without notice.

□ Appearance

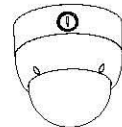

● Main Unit

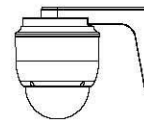

● Wall Mount Bracket

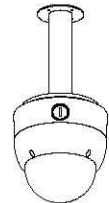

● Ceiling Mount

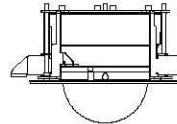

● Embedded Mount Bracket

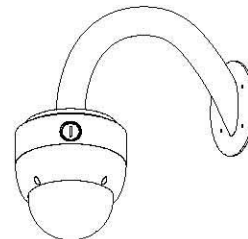

● Wall Mount

□ OSD(On Screen Display)Menu

- OSD menu is provided to display the status of camera and to configure the functions interactively.
- The information such as Camera ID, Pan/Tilt Angle, Alarm Input and Preset can be displayed on screen.

□ Alarm I/O Functions

- 4 alarm sensor Inputs are available.
- To reject external electric noise and shock perfectly, alarm sensor Input is decoupled with photo coupler.
- The signal range of sensor input is from DC 5.0 to 12.0 volts to adopt various applications.
- If an external sensor is activated, camera can be set to move to the corresponding Preset position.

□ Reserved Presets for Special Purpose

- Most camera characteristics can be set up easily and directly with reserved preset, not entering into OSD menu. For more information, refer to "Reserved Preset" in this manual.

Product & Accessories

Product & Accessories

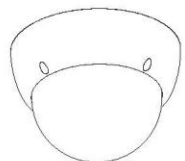
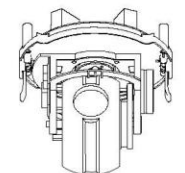
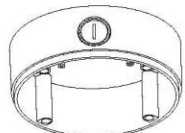

● Main Body

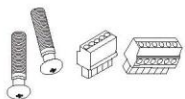

● Screws & Terminal Block

Options

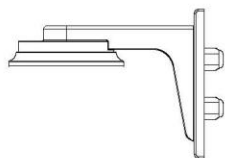

● Wall Mount Bracket

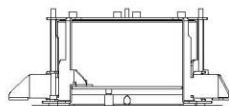

● Embedded Mount Bracket

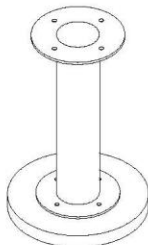

● Ceiling Mount Bracket

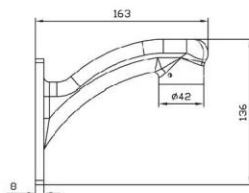

● Wall Mount Bracket

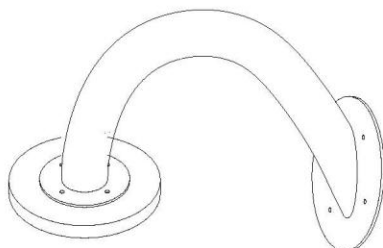

● Wall Mount Bracket

System Initialize

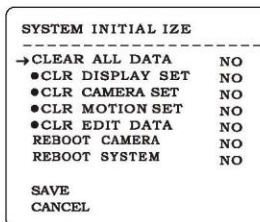

- Clear All Data      Deletes all configuration data such as display, camera, motion setup and so on.
- Clear Display Set    Initializes Display Configuration
- Clear Camera Set    Initializes Camera Configuration
- Clear Motion Set    Initializes Motion Configuration
- Clear Edit Data     Deletes Preset Date, Swing Data, Pattern Data and Group Data
- Reboot Camera        Reboots Zoom Camera module
- Reboot System        Reboots Speed Dome Camera

Initial Configuration Table

● Display Configuration		● Camera Configuration	
Camera ID	ON	Focus Mode	SemiAuto
PTZ Information	AUTO	Digital Zoom	ON
Action Title	AUTO	Line Lock	OFF
Preset Label	AUTO	White Balance	AUTO
Alarm Input	AUTO	Backlight	OFF
North Direction	Pan 0°	Day&Night	AUTO1
Privacy Zone	Undefined	Brightness	25
		Iris	AUTO
		Shutter	ESC
● Motion Configuration		AGC	NORMAL
Motion Lock	OFF	SSNR	MIDDLE
Power Up Action	ON	SENS-UP	AUTO (4 Frame)
Auto Flip	ON		
Jog Max Speed	120°/sec	● User Edit Data	
Jog Direction	INVERSE	Preset 1~128	Undefined
Freeze In Preset	OFF	Swing 1~8	Undefined
Park Action	OFF	Pattern 1~4	Undefined
Alarm Action	OFF	Group 1~8	Undefined

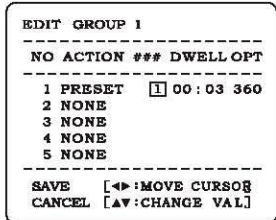

④ Set up Items such as Action, ###, Dwell and OPT.

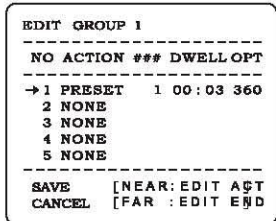

⑤ After finishing setting up a Action, Press Near key to one-upper-level menu(Step ②). Move cursor Up/Down to select Action number and repeat Step ②~Step ④ to edit selected Group.

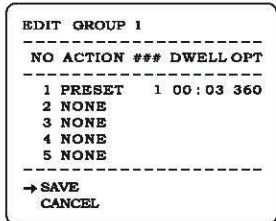

⑥ After finishing setting up all Action, Press FAR key to exit. Then cursor should be moved to "SAVE", Press Near key to save data.

## DIP Switch Setup

Before you install the camera, you should set the DIP switches to configure the camera ID, communication protocol.

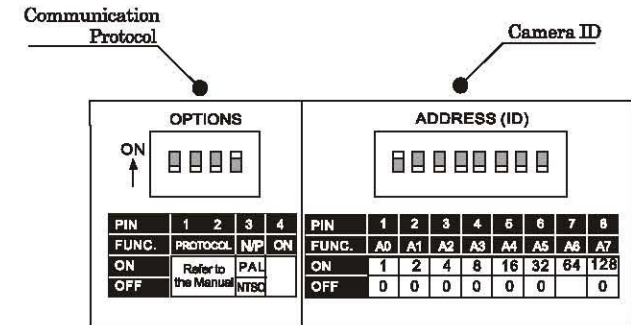

## □ Camera ID Setup

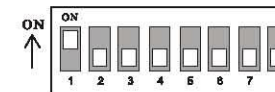

● ID number of camera is set using binary number. The example is shown below.

Pin	1	2	3	4	5	6	7	8
ID Value	1	2	4	8	16	32	64	128
ex) ID=5	On	Off	On	Off	Off	Off	Off	Off
ex ID=10	Off	On	Off	On	Off	Off	Off	Off

- The range of ID is 1~255. Do not use 0 as camera ID. Factory default of Camera ID is 1.
- If you want to control a certain camera, you must match the camera ID with Cam ID setting of DVR or Controller.



## □ Communication Protocol Setup

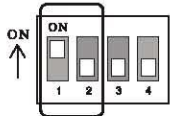

- Select the appropriate Protocol with DIP switch combination.

Switch State		Protocol
P0 (Pin 1)	P1 (Pin 2)	
OFF	OFF	PELCO-D,2400 bps
ON	OFF	PELCO-D,9600 bps
OFF	ON	PELCO-P,4800 bps
ON	ON	PELCO-P,9600 bps

- If you want to control using DVR or P/T controller, their protocol must be identical to camera. Otherwise, you can not control the camera.
- If you changed camera protocol by changing DIP S/W, the change will be effective after you reboot the camera.
- Factory default of protocol is "Pelco-D, 2400 bps"

## □ Reserved for Supplier

- Since Pin 3~Pin 4 is only for supplier, DO NOT CHANGE THESE ORIGINAL STATE. If you change one of these, proper operation can not be achieved.
  - Pin 3 PAL / NTSC system selection of Camera. DO NOT CHANGE THIS PIN.
  - Pin 4 Factory default is ON state. This pin is used for system firmware upgrade. DO NOT CHANGE THIS PIN.



## Group Setup

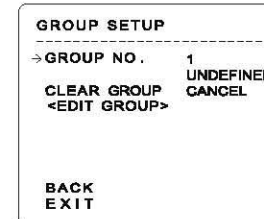

- Group Number [1~8]
  - Selects Group number to edit.
  - If a selected Group number is not defined, "UNDEFINED" will be displayed under selected Group number.
- Clear Group [CANCEL/OK]
  - Deletes data in current Group
- Edit Group Starts editing Group.

## □ Edit Group

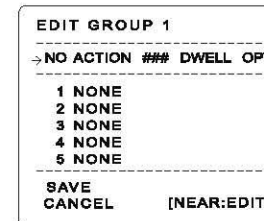

- ① Press Near key in "NO" list to start Group setup.

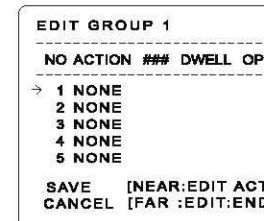

- ② Note that MAX.20 Functions are allowed in a Group. Move cursor up/down and press Near key to set up.

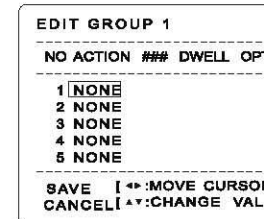

- ③ Set up Action, Dwell time and Option. Note that selected item is displayed in reverse. Move cursor Left/Right to select items and move cursor Up/Down to change each value.
  - Action ### [NONE/PRESET/SWING/PATTERN]
  - DWELL [0 second~4 minutes]
    - Sets Dwell Time between functions
  - OPT Option. It should be preset speed when preset is set in Action It should be the number of repeat when Pattern or Swing is selected In Action

## Pattern Setup

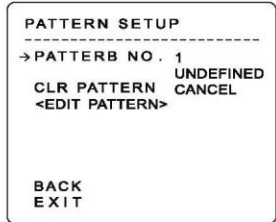

- **Pattern Number** [1~4]  
Selects Pattern number to edit.  
If a selected pattern number is not defined, "UNDEFINED" will be displayed under selected pattern number.
- Clear Pattern** [CANCEL/OK]  
Deletes data in current pattern
- Edit Patternk** Starts editing pattern.

### □ Edit Pattern

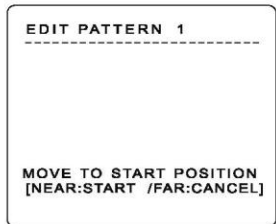

- ① By using Joystick, move to start position with appropriate zoom. To start pattern recording, press NEAR key. To exit this menu, press FAR key.

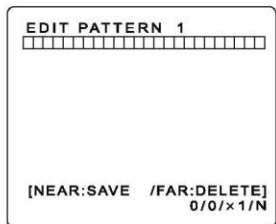

- ② Move camera with joystick of controller or run preset function to memorize the path (mostly curve path) in a selected pattern. The total memory size and the rest memory size is displayed in the form of bar. Maximum 1200 communication commands can be stored in a pattern
- ③ To save data and exit, press NEAR key. To cancel recording and delete record data, press FAR key.

## Cable connection

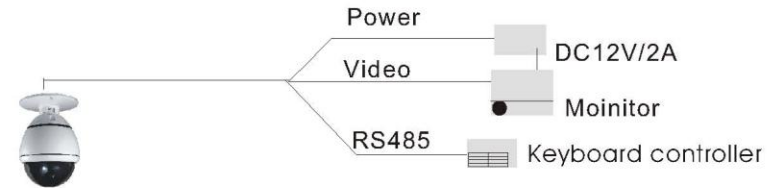

### □ Power Connection

- Please, check the voltage and power consumption carefully. Power supply is indicated in the back of main unit.

Supply Power	Input Voltage Range	Power Consumption
DC 12V	DC 11V~18 V	0.8A

### □ RS-485 Communication

- For PTZ control, connect this line to keyboard and DVR. To control multiple cameras at the same time, RS-485 communication lines of them is connected in parallel as shown below.

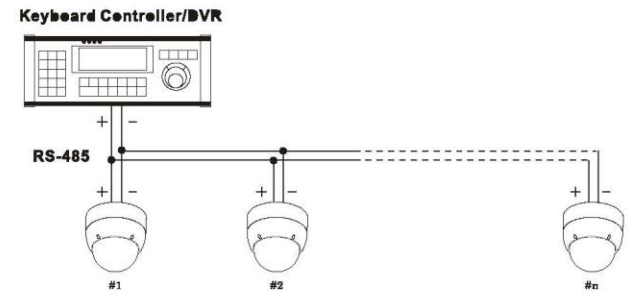

Power

DC12V/2A

Video

Monitor

RS485

Keyboard controller

□ Video Connection.

- Connect with BNC tap cable.

□ Alarm input Connection

- Sensor Input

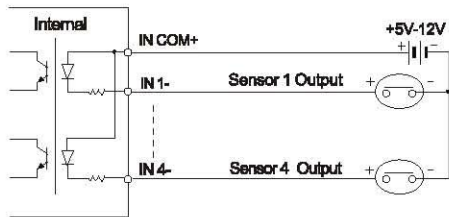

Before connecting sensors, check driving voltage and output signal type of the sensor. Since output signal types of the sensors are divided into Open Collector and Voltage Output type in general, the cabling must be done properly after considering these types.

Signal	Description
IN COM+	Connect (+) cable of electric power source for Sensors to this port as shown in the circuit above.
IN1-,IN2-,IN3-,IN4-	Connect output of sensors for each port as shown in the circuit above.

If you want to use Alarm Input, the types of sensor must be selected in OSD menu. The sensor types are Normal Open and Normal. If sensor type is not selected properly, the alarm can be activated reversely.

☉ Normal Open	Output Voltage is high state when sensor is activated
☉ Normal Close	Output Voltage is high state when sensor is not activated

## Swing Setup

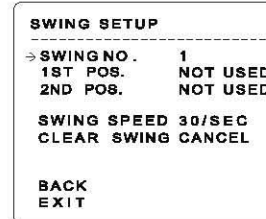

- **Swing Number** [1-8]  
Selects Swing number to edit. If a selected Swing has not defined, "NOT USED" is displayed in 1st Position and 2nd Position
- **1st Position** [PRESET 1-128]  
**2nd Position** Set up the 2 position for Swing function If a selected preset is not defined, "UNDEFINED" will be displayed as shown below.

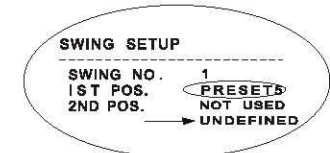

When swing function runs, camera moves from the preset assigned as the 1st point to the preset assigned as the 2nd point in CW (Clockwise) direction. Then camera moves from the preset assigned as the 2nd point to the preset assigned as the 1st point in CCW (Counterclockwise) direction. In case that the preset assigned as the 1st point is same as the preset assigned as the 2nd point, camera turns on its axis by 360° in CW direction and then it turns on its axis by 360° in CCW direction

- **Swing Speed** [1°/sec~180°/sec]  
Sets Swing speed from 1°/sec to 180°/sec.
- **Clear Swing** [CANCEL/OK]  
Deletes current Swing data

### □ Edit Preset Scene

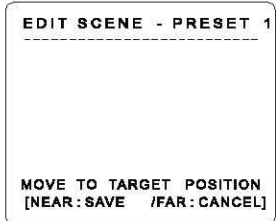

- ① Using Joystick, move camera to desired position.
- ② By pressing NEAR key, save current PTZ data.
- ③ Press FAR key to cancel.

### □ Edit Preset Label



- ① Edits label to show on monitor when camera arrives at presets. In Edit Label menu, a reverse rectangular is cursor as soon as finishing selecting alphabet, cursor moves to the next digit



- ② Using Left/Right/Up/Down of joystick, move to an appropriate character from the Character set. To choose that character, press the NEAR key.



Space Char. Back Space Char

If you want to use blank, choose Space character (" "). If you want to delete a character before, use back space character ("←").

- ③ If you complete the Label editing, move cursor to "OK" and press NEAR key to save completed label. To abort current change, move cursor to "Cancel" and press NEAR key.

### Check points before operation

- Before power is applied, please check the cables carefully.
- The camera ID of the controller must be identical to that of the target camera. The camera ID can be checked by reading DIP switch of the camera.
- If your controller supports multi-protocols, the protocol must be changed to match to that of the camera.
- If you changed camera protocol by changing DIP switch, the change will be effective after you reboot the camera
- Since the operation method can be different for each controller available, refer to the manual for your controller if camera can not be controlled properly. The operation of this manual is based on the standard Pelco® Controller.

### Preset and pattern Function Pre-Check

- Check how to operate preset and pattern function with controller or DVR in advance to operate camera function fully when using controller or DVR.
- Refer to the following table when using standard Pelco® protocol controller.

<Go Preset>	Input[Preset Number] and press [Preset] button shortly.
<Set Preset>	Input[Preset Number] and press [Preset] button for more than 2 seconds.
<Run Pattern>	Input[Pattern Number] and press [Preset] button shortly.
<Set Pattern>	Input[Pattern Number] and press [Preset] button for more than 2 seconds.

- If controller or DVR has no pattern button or function, use shortcut keys with preset numbers. For more information, refer to "Reserved Preset" in this manual

## Starting OSD Menu

- **Function** Using the OSD menu, Preset, Pattern, Swing, Group and Alarm Input function can be configured for each application.
- **Enter Menu** <Go Preset> [95]

## Reserved Preset

- **Description** Some Preset numbers are reserved to special functions.
- **Function**
  - <Go Preset> [95] :Enters into OSD menu
  - <Go Preset> [131~134] :Runs Pattern Function 1~4
  - <Go Preset> [141~148] :Runs Swing Function 1~8
  - <Go Preset> [151~158] :Runs Group Function 1~8
  - <Go Preset> [170] :Sets Camera BLC Mode to OFF
  - <Go Preset> [171] :Sets Camera BLC Mode to ON
  - <Go Preset> [174] :Sets Camera Focus Mode to AUTO
  - <Go Preset> [175] :Sets Camera Focus Mode to Manual
  - <Go Preset> [176] :Sets Camera Focus Mode to SEMI—AUTO
  - <Go Preset> [177] :Sets Day & Night Mode to AUTO
  - <Go Preset> [178] :Sets Day & Night Mode to NIGHT
  - <Go Preset> [179] :Sets Day & Night Mode to DAY
  - <Go Preset> [190] :Sets OSD Display Mode to AUTO (Except Privacy Mask)
  - <Go Preset> [191] :Sets OSD Display Mode to OFF (Except Privacy Mask)
  - <Go Preset> [192] :Setting OSD Display Mode to ON (Except Privacy Mask)
  - <Go Preset> [193] :Sets all Privacy Mask Display to OFF
  - <Go Preset> [194] :Sets all Privacy Mask Display to ON

## PRESET Setup

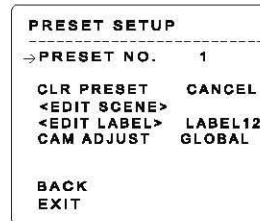

- **Preset Number** [1~128]  
If a selected preset is already defined, camera moves to pre-defined position and preset characteristics such as Label and Relay Outputs show on monitor. If a selected preset is not defined, "UNDEFINED" shows on monitor.
- **Clear Preset** [CANCEL/OK]  
Delete current Preset data
- **Edit Preset Scene** Redefine current Preset scene position(1. e PTZ)
- **Edit Preset Label** Edits Label to show on monitor when preset runs  
MAX. 10 alphabets are allowed
- **CAM Adjust** [GLOBAL/LOCAL]  
WB (White Balance) and AE (Auto Exposure) can be set up independently for each preset. There are 2 modes, "Global" mode & "Local" mode. The Global mode means that WB or AE can be set up totally and simultaneously for all presets in "ZOOM CAMERA SETUP" menu.  
The Local mode means that WB or AE can be set up independently or separately for each preset in each preset setup menu. Each Local WB/AE value should activate correspondingly when camera arrives at each preset location. During jog operation, Global WB/AE value should be applied.  
All Local WB/AE value should not change although Global WB/AE value changes. If "Local" is selected, Menu to set WB/AE shows on Monitor.

## □ Parking Action Setup

## PARKING ACTION SETUP

```

-----
->PARK ENABLE  OFF
   WAIT TIME  00:10:00
   PARK ACTION  HOME
  
```

```

BACK
EXIT
  
```

If Park Enable is set to ON, camera runs assigned function automatically if there is no PTZ command during assigned "Wait Time".

- Park Enable [ON/OFF]
- Wait Time [1 minute~4 hour]  
The time is displayed with "hh:mm:ss" format and you can change this by 1 min unit.
- Park Action [HOME/PRESET/PATTERN/SWING/GROUP]
  - HOME  
Camera moves to home position if there is no PTZ command during assigned "Wait Time".

## □ Alarm Input Setup

## ALARM INPUT SETUP

```

-----
ALARM1TYPE  N.OPEN
ALARM2TYPE  N.OPEN
ALARM3TYPE  N.OPEN
ALARM4TYPE  N.OPEN
ALARM1ACT   NOT USED
ALARM2ACT   NOT USED
ALARM3ACT   NOT USED
ALARM4ACT   NOT USED
BACK
EXIT
  
```

Match the Alarm sensor input to one of Preset positions. If an external sensor is activated, camera will move to corresponding preset position when this item is predefined.

- Alarm×Type [Normal OPEN/Normal CLOSE]  
Sets sensor input type.
- Alarm×Action [NOT USED/PRESET 1~128]  
Assign counteraction Preset position to each Alarm input.

## Preset

- Function Max 127 positions can be stored as Preset position. The Preset number can be assigned from 1 to 128, but 95 is reserved for starting OSD menu.  
Camera characteristics (I.e. White Balance, Auto Exposure) can be set up independently for each preset. Label should be blank and "Camera Adjust" should be set to "GLOBAL" as default. All characteristics can be set up in OSD menu.
- Set Preset <Set Preset>[1~128]
- Run Preset <Go Preset>[1~128]
- Delete Preset To delete Preset, use OSD menu.

## Swing

- Function By using Swing function, you can make camera to move between 2 Preset positions repeatedly. When swing function runs, camera moves from the preset assigned as the 1st point to the preset assigned as the 2nd point in CW(Clockwise)direction. Then camera moves from the preset assigned as the 2nd point to the preset assigned as the 1st point in CCW(Counterclockwise)direction.

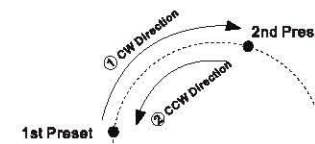

In case that the preset assigned as the 1st point is same as the preset assigned as the 2nd point, camera turns on its axis by 360° in CW(Clockwise)direction and then it turns on its axis by 360° in CCW(Counterclockwise) direction.

Speed can be set up from 1°/sec to 180°/sec.

- Set Preset To set Swing, use OSD menu
- Run Swing
 

Method 1) <Run Pattern>[Swing NO. +10]	ex) Run Swing 3: <Run Pattern>[13]
Method 2) <Go Preset>[Swing NO. +140]	ex) Run Swing 3: <Go Preset>[143]
- Delete Swing To delete Swing, use OSD menu.

## Pattern

**● Function** Pattern Function is that a camera memorizes the path (mostly curve path) by joystick of controller for assigned time and revives the path exactly as it memorized.  
4 Patterns are available and Maximum 1200 communication commands can be stored in a pattern.

**● Set Pattern** Pattern can be created by one of following two methods.

Method 1) <Set Pattern> [Pattern NO.]

- Pattern editing screen is displayed as below.

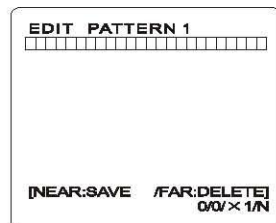

- Movement by Joystick and preset movement can be memorized in a pattern.
- The rest memory size is displayed in progress bar.
- To save the recording, press NEAR key and to cancel, press FAR key.

Method 2) OSD Using OSD Menu: See the section "How to use OSD Menu".

**● Run Pattern** Method 1) <Run Pattern>[Pattern NO.]    ex)Run Pattern 2: <Run Pattern>[2]  
Method 2) <Go Preset> [Pattern NO. +130]    ex)Run Pattern 2: <Go Preset>[132]

**● Delete Pattern** Use OSD menu to delete a Pattern

## Motion Setup

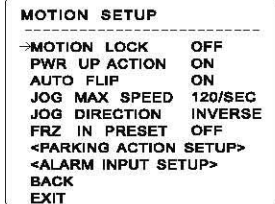

Setup the general functions of Pan/Tilt motions.

- Motion Lock** [ON/OFF]  
If Motion Lock is set to ON, it is impossible to set up and delete Preset, Swing, Pattern and Group. It is possible only to run those functions. To set up and delete those functions, enter into OSD menu.
- Power Up Action** [ON/OFF]  
Refer to "Other Functions" section.
- Auto Flip** [ON/OFF]  
Refer to "Other Functions" section.
- Jog Max Speed** [1°/sec~360°/sec]  
Sets maximum jog speed. Jog speed is inversely proportional to zoom magnification. As zoom magnification goes up, pan/tilt speed goes down
- Jog Direction** [INVERSE/NORMAL]  
If you set this to 'Inverse', the view in the screen is moving same direction with jog tilting. If 'Normal' is selected, the view in the screen is moving reversely.
- Freeze in Preset** [ON/OFF]  
At start point of preset movement, camera starts freezing the image of start point. Camera keeps displaying the image of start point during preset movement and does not display the images which camera gets during preset movement. As soon as camera stops at preset end point, camera starts displaying live images which it gets at preset end point.  
  
This function availability should be different by models.



## □ Auto Exposure Setup

AE SETUP - GLOBAL	
→BACKLIGHT	OFF
DAY/NIGHT	AUTO1
BRIGHTNESS	25
IRIS	AUTO
SHUTTER	ESC
AGC	NORMAL
SSNR	MIDDLE
SENG-UP	<AUTO>
BACK	
EXIT	

- **Backlight** [ON/OFF]  
Sets Backlight Compensation
- **Day/Night** [AUTO1/AUTO2DAY/NIGHT]  
AUTO1 exchanges Day/Night mode faster than AUTO2.
- **Brightness** [0~100]  
Adjusts brightness of images. Iris, Shutter Speed and Gain are adjusted automatically in correspondence with this value
- **IRIS** [AUTO/MANUAL(0~100)]  
If Iris is set to Auto, Iris should have highest priority in adjusting AE and Shutter Speed should be fixed.  
If Iris is set to Manual, Iris should be fixed and Iris has lower priority in adjusting AE, in comparison with others.
- **Shutter Speed** [ESC/A. Flicker/Manual(x128~1/120000 sec)]  
If Iris is set to Manual and Shutter Speed is set to ESC, Shutter Speed should have highest priority. If Shutter Speed is set to A. Flicker, to remove Flicker, Shutter Speed should be set to 1/100 secretary. for NTSC and 1/120 for PAL.
- **AGC** [OFF/NORMAL/HIGH]  
Enhances image brightness automatically in case that luminance level of image signal is too low.
- **SSNR** [OFF/LOW/MIDDLE/HIGH]  
Enhances images by deducting noises when gain level of images is too high.
- **SENS-UP** [AUTO(2~128)/OFF]  
Activates Slow Shutter function when luminance of Image(signal) is too dark  
It is possible to set up the maximum number of frames piled up one on another by Slow Shutter function.



## Group

- **Function** The group function allows running sequence of Presets, Pattern and/or Swings Max 8 group can be stored. Each group can have max 20 action entities which can be preset, pattern or swing. Preset speed can be set up and the repeat number of Pattern & Swing can be set up in Group setup. Dwell time between actions can be set up also.

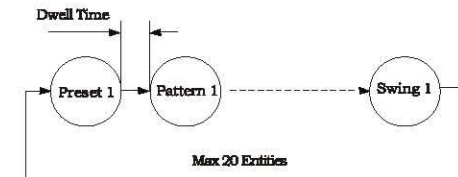

- **Set Group** Use OSD Menu to create a Group
- **Run Group** Method 1) <Run Pattern>[Group NO+20] ex) Run Group 7: <Run Pattern>[27]  
Method 2) <Go Preset>[Group NO. +150] ex) Run Group 7: <Go Preset>[157]
- **Delete Group** Use OSD Menu to delete

Other Functions

- **Power Up Action** This function enables to resume the last action executed before power down. Most of actions such as Preset, Pattern, Swing and Group are available for this function but jog actions are not available to resume.
- **Auto Flip** In case that tilt angle arrives at the top of tilt orbit (90°), zoom module camera keep moving to opposite tilt direction (180°) to keep tracing targets. As soon as zoom module camera passes through the top of tilt direction(90°), images should be reversed automatically and **F** appears in screen. If this function is set to OFF, tilt movement range is 0~95°.
- **Parking Action** This function enables to locate the camera to specific position automatically if operator doesn't operate the controller for a while. The Park Time can be defined as an interval from 1 minute to 4 hours.
- **Alarm Input** 4 Alarm Inputs are used. If an external sensor is activated, camera can be set to move to corresponding preset position. It is noted that the latest alarm input is effective if multiple sensors are activated.
- **Privacy Zone Mask** To protect privacy, MAX. 4 Privacy Masks can be created on the arbitrary position to hide objects such as windows, shops or private house. With Spherical Coordinates system, powerful Privacy Zone Mask function is possible
- **GLOBAL/LOCAL Image Setup** WB(White Balance) and AE (Auto Exposure) can be set up independently for each preset. There are 2 modes, "Global" mode & "Local" mode. The Global mode means that WB or AE can be set up totally and simultaneously for all presets in "ZOOM CAMERA SETUP" menu. The Local mode means that WB or AE can be set up independently or separately for each preset in each preset setup menu. Each Local WB/AE value should activate correspondingly when camera arrives at each preset location.  
  
During jog operation, Global WB/AE value should be applied. All Local WB/AE value do not change although Global WB/AE value changes.
- **SemiAuto Focus** This mode exchanges focus mode automatically between Manual Focus mode and Auto Focus mode by operation. Manual Focus mode activates in preset operation and Auto Focus mode activates during jog operation. With Manual mode at presets, Focus data is memorized in each preset in advance and camera calls focus data in correspondence with presets as soon as camera arrives at a preset. It should shorten time to get focuses. Focus mode changes to Auto Focus mode automatically when jog operation starts.

CAMERA SETUP

```
ZOOM CAMERA SETUP
-----
-> FOCUS MODE      SEMIAUTO
DIGITAL ZOOM ON
LINE LOCK OFF
<WHITE BALANCE SETUP>
<AUTO EXPOSURE SETUP>

BACK
EXIT
```

Setup the general functions of zoom camera module

- **Focus Mode** [AUTO/MANUAL/SEMIAUTO]
  - **SEMIAUTO Mode**  
This mode exchanges focus mode automatically between Manual Focus mode and Auto Focus mode. Manual Focus mode activates in preset operation and Auto Focus mode activates when jog operation Starts.  
  
With Manual mode at presets, Focus data is memorized in each preset in advance and camera calls focus data in correspondence with presets as soon as camera arrives at a preset.
- **Digital Zoom** [ON/OFF]
  - Sets digital zoom function to ON/OFF. If this is set to OFF, optical zoom function runs but zoom function stops at the end of optical zoom magnification.
- **Line Lock** [ON/OFF]
  - If Line lock sync is ON, video signal is synchronized with AC power. Video can be fluctuated after setting is changed.

White Balance Setup

```
WB SETUP - GLOBAL
-----
->WB MODE      AUTO
RED ADJUST ---
BLUE ADJUST ---

BACK
EXIT
```

- **WB Mode** [AUTO/MANUAL]
  - In Manual mode, Red and Blue level can be set up manually
- **Red Adjust** [10~60]
- **Blue Adjust** [10~60]

## PRIVACY ZONE MASK Setup

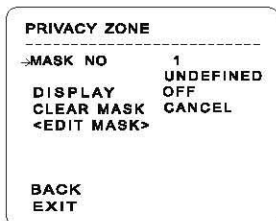

Select area in image to mask.

- **Mask No** [1~4]  
Select Mask number. If the selected mask has already data, camera moves as it was set. Otherwise, "UNDEFINED" will be displayed under "Mask No" .
- **Display** [ON/OFF]  
Sets if camera makes mask shows or not on images
- **Clear Mask** [CANCEL/OK]  
Deletes data in the selected mask NO .

### □ Privacy Zone Area Setup

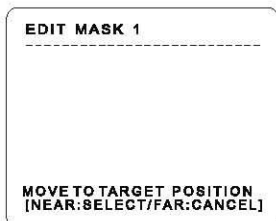

Move camera to area to mask. Then the menu to adjust mask size will be displayed.

### □ Privacy Zone Size Adjustment

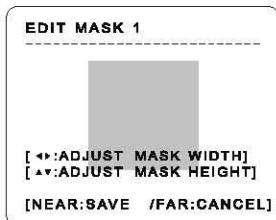

Adjust mask size. Use joystick or arrow buttons to adjust mask size.

- ◀ ▶ (Left/Right) Adjusts mask width.
- ▲ ▼ (Up/Down) Adjusts mask height.

## OSD Display of Main Screen

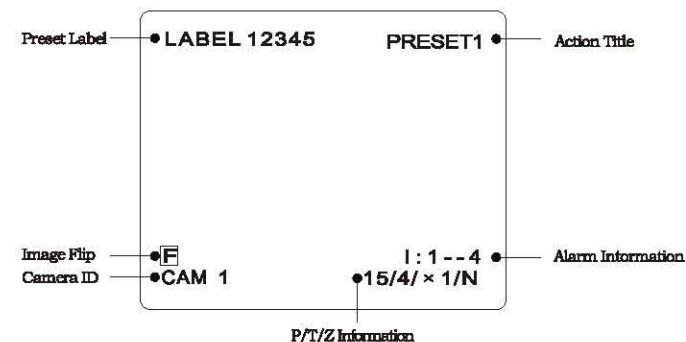

- **P/T/Z Information** Current Pan/Tilt angle in degree, zoom magnification and a compass direction.
- **Camera ID** Current Camera ID(Address).
- **Action Title** Followings are possible Action-Titles and their meaning.
 

"SET PRESET ×××"	When Preset××× is stored
"PRESET×××"	When camera reach to Preset ×××
"PATTERN ×"	When Pattern × is in action
"SWG×/PRESET×××"	When Swing× is in action
"UNDEFINE D"	When undefined function is called to run
- **Preset Label** The Label stored for specific Preset.
- **Alarm Input** This information shows current state of Alarm Input. If an Input point is ON state it will show a number corresponding to each point If an Input point is OFF state, '-' will be displayed  
Ex)Point 2&3 of inputs are ON, OSD will show as below  

I : -23-
- **Image Flip** Shows that images are currently reversed by Auto nip Function.

## General Rules of Key Operation for Menu

- The menu items surrounded with ( ) always has its sub menu.
- For all menu level, to go into sub menu, press NEAR key.
- To go to up-one-level menu, press FAR key.
- To move from items to item in the menu, use joystick in the Up/Down or Left/Right.
- To change a value of an item, use Up/Down of the joystick in the controller.
- Press NEAR key to save values and Press FAR key to cancel Values.

## Main Menu

### SPEED DOME CAMERA

```

-><SYSTEM INFORMATION>
<DISPLAY SETUP>
<DOME CAMERA SETUP >
<SYSTEM INITIALIZE>

EXIT
    
```

- **System Information** Displays system information and configuration.
- **Display Setup** Enable/Disable of OSD display on Main Screen.
- **Dome Camera Setup** Configure various functions of this camera.
- **System Initialize** Intializes system configuration and sets all data to factory default configuration

## Display Setup

### DISPLAY SETUP

```

->CAMERA ID ON
PTZ INFORMATION AUTO
ACTION TITLE AUTO
PRESET LABEL AUTO
ALARM INPUT AUTO
<SET NORTH DIRECTION>
<PRIVACY ZONE>

BACK
EXIT
    
```

This menu defines Enable/Disable of OSD display on Main Screen. If an item is set to be AUTO, the item is displayed only when the value of it is changed.

- Camera ID [ON/OFF]
- PTZ Information [ON/OFF/AUTO]
- Action Title [ON/OFF/AUTO]
- Preset Label [ON/OFF/AUTO]
- Alarm Input [ON/OFF/AUTO]

## Compass Direction Setup

### SET NORTH DIRECTION

```

MOVE TO TARGET POSITION
[NEAR:SAVE /FAR:CANCEL]
    
```

Set North to assign compass direction as criteria. Move camera and press NEAR button to save.

